

Specifications

- Current rating: 3A AC, DC
- Voltage rating: 250V AC, DC
- Temperature range: -40°C ~ +105°C
- Contact resistance: 20mΩ Max.
- Insulation resistance: 1000MΩ Min.
- Withstanding voltage: 1000V AC/minute
- *Compliant with RoHS and REACH*
- *Meet the HF/Halogen Free, need to customize*
- *Contact CJT for details*

Standards



Assembly layout

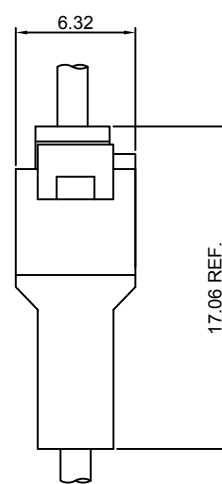
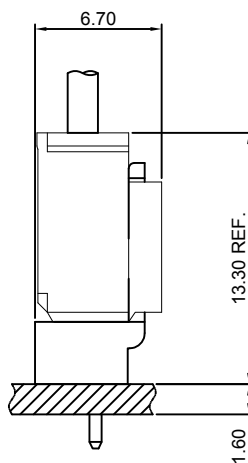
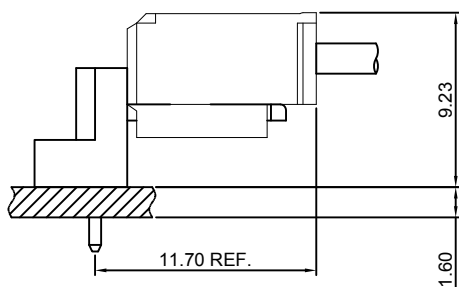

Panel hole layout

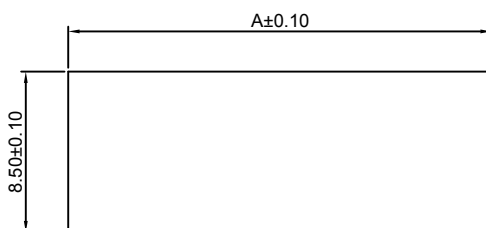

PART NO.	Dimensions
	A
C2504HM-2P	12.40
C2504HM-3P	14.90
C2504HM-4P	17.40
C2504HM-5P	19.90
C2504HM-6P	22.40
C2504HM-7P	24.90
C2504HM-8P	27.40
C2504HM-9P	29.90
C2504HM-10P	32.40
C2504HM-11P	34.90
C2504HM-12P	37.40

Unit:mm

C2504HFA-XP

2.50mm Pitch Housing

Reference Informations:

- *Material:Nylon 66,UL94V-0
- *Suitable CJT A2509-T-A series Terminal
- *Mates with CJT C2504HM,HMA,HMB-XP series Housing or C2504WV,WR-XP,C2504WVR-XP series Wafer
- *Color:Beige

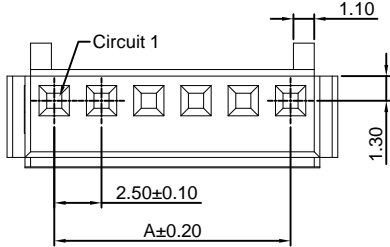
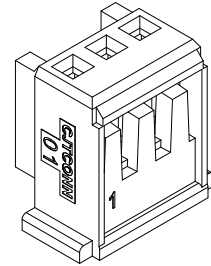

Ordering Information:
C2504HFA-XP - *** - **
1 2 3

- Part No.
- Material:
(blank):Nylon 66,UL94V-0
GWT:Nylon 66,UL94V-0,GWT 750°C
- Color:
(blank):Beige
WH:White

Ordering Information & Dimensions:

PART NO.	Dimensions	
	A	B
2P	2.50	5.60
3P	5.00	8.10
4P	7.50	10.60
5P	10.00	13.10
6P	12.50	15.60
7P	15.00	18.10
8P	17.50	20.60
9P	20.00	23.10
10P	22.50	25.60
11P	25.00	28.10
12P	27.50	30.60
13P	30.00	33.10
14P	32.50	35.60
15P	35.00	38.10
16P	37.50	40.60
17P	40.00	43.10
18P	42.50	45.60
19P	45.00	48.10
20P	47.50	50.60

Unit: mm

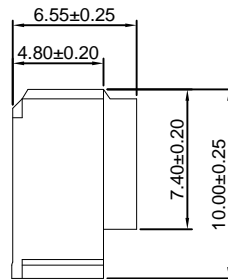
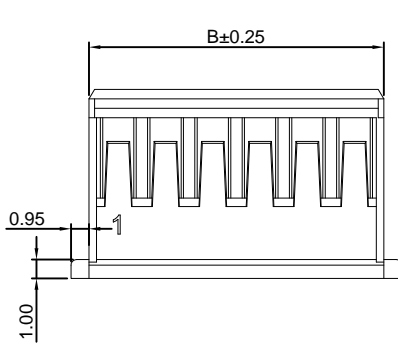

C2504AH-XP

2.50mm Pitch Housing

Reference Informations:

- *Material:Nylon 66,UL94V-0
- *Suitable CJT A2543-T series Terminal
- *Mates with CJT C2504WV,WR-XP, C2504WVR-XP series Wafer
- *Color:Beige

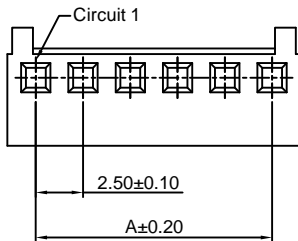
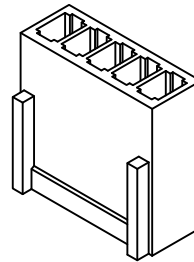

Ordering Information:
C2504AH-XP - *** - **
1 2 3

- Part No.
- Material:
(blank):Nylon 66,UL94V-0
GWT:Nylon 66,UL94V-0,GWT 750°C
- Color:
(blank):Beige
WH:White

Ordering Information & Dimensions:

PART NO.	Dimensions	
	A	B
2P	2.50	5.50
3P	5.00	8.00
4P	7.50	10.50
5P	10.00	13.00
6P	12.50	15.50
7P	15.00	18.00
8P	17.50	20.50
9P	20.00	23.00
10P	22.50	25.50
11P	25.00	28.00
12P	27.50	30.50
13P	30.00	33.00
14P	32.50	35.50
15P	35.00	38.00
16P	37.50	40.50
17P	40.00	43.00
18P	42.50	45.50
19P	45.00	48.00
20P	47.50	50.50

Unit: mm

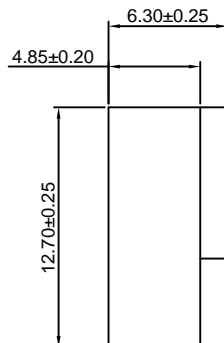
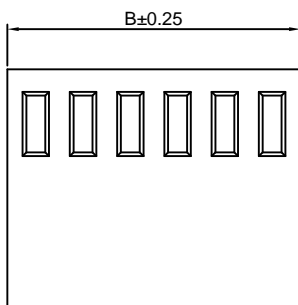

C2504HM-XP

2.50mm Pitch Housing

Reference Informations:

- *Material:Nylon 66, UL94V-0
- *Suitable CJT A2501M-T series Terminal
- *Mates with CJT C2504HFA-XP series Housing
- *Color:Beige

Ordering Information:
C2504HM-XP - *** - **
1 2 3

- 1.Part No.
- 2.Material:
(blank):Nylon 66,UL94V-0
GWT:Nylon 66,UL94V-0,GWT 750°C
- 3.Color:
(blank):Beige
WH:White

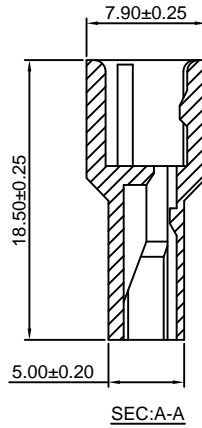
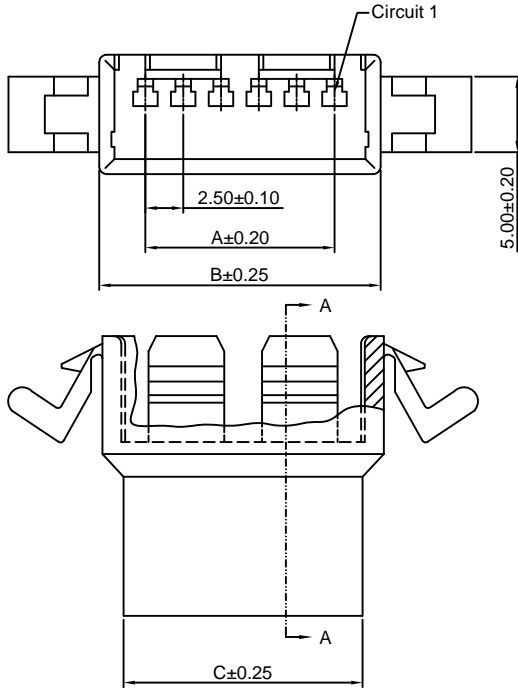
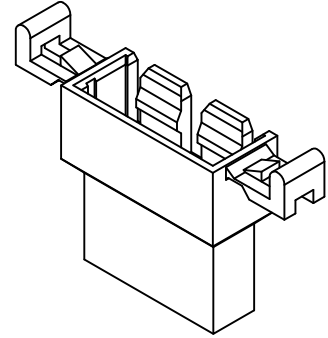

Ordering Information & Dimensions:

PART NO.	Dimensions		
	A	B	C
2P	2.50	8.60	5.80
3P	5.00	11.10	8.30
4P	7.50	13.60	10.80
5P	10.00	16.10	13.30
6P	12.50	18.60	15.80
7P	15.00	21.10	18.30
8P	17.50	23.60	20.80
9P	20.00	26.10	23.30
10P	22.50	28.60	25.80
11P	25.00	31.10	28.30
12P	27.50	33.60	30.80

Unit: mm

C2504HMA-XP

2.50mm Pitch Housing

Reference Informations:

- *Material:Nylon 66, UL94V-0
- *Suitable CJT A2501M-T series Terminal
- *Mates with CJT C2504HFA-XP series Housing
- *Color:Beige

Ordering Information:
C2504HMA-XP - *** - **
1 2 3

- 1.Part No.
- 2.Material:
(blank):Nylon 66,UL94V-0
GWT:Nylon 66,UL94V-0,GWT 750°C
- 3.Color:
(blank):Beige
WH:White

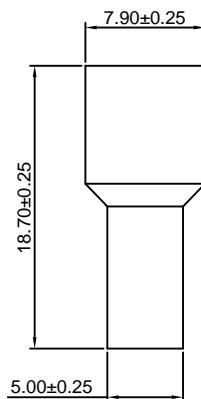
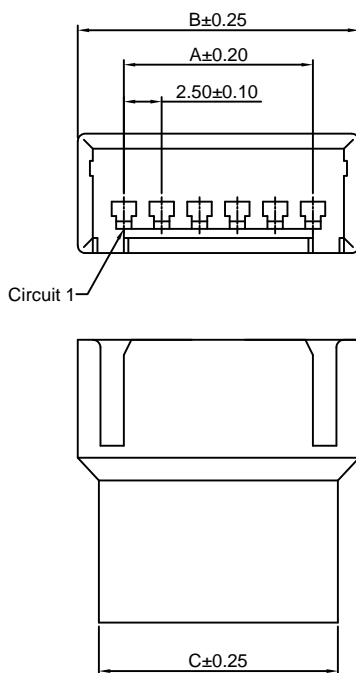
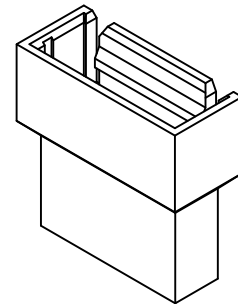

Ordering Information & Dimensions:

PART NO.	Dimensions		
	A	B	C
2P	2.50	8.60	5.80
3P	5.00	11.10	8.30
4P	7.50	13.60	10.80
5P	10.00	16.10	13.30
6P	12.50	18.60	15.80
7P	15.00	21.10	18.30
8P	17.50	23.60	20.80
9P	20.00	26.10	23.30
10P	22.50	28.60	25.80
11P	25.00	31.10	28.30
12P	27.50	33.60	30.80

Unit: mm

C2504HMB-XP

2.50mm Pitch Housing

Reference Informations:

- *Material:Nylon 66, UL94V-0
- *Suitable CJT A2501M-T series Terminal
- *Mates with CJT C2504HFA-XP series Housing
- *Color:White

Ordering Information:

C2504HMB-XP - ***
 1 2

- 1.Part No.
- 2.Material:
 (blank):Nylon 66,UL94V-0
 GWT:Nylon 66,UL94V-0,GWT 750°C

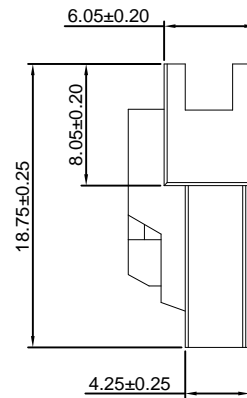
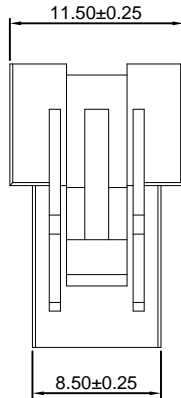
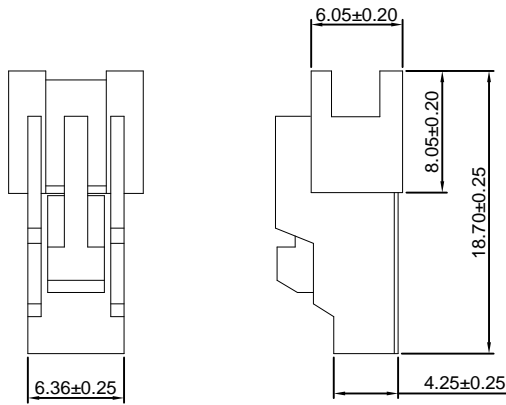
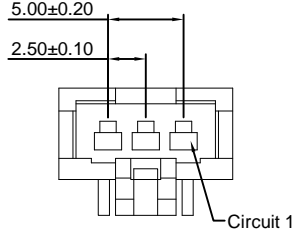
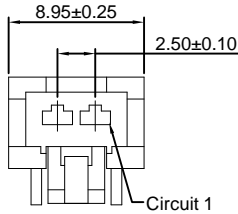
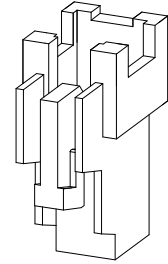

2P

3P

C2504WV-XP

2.50mm Pitch 180° Wafer

Reference Informations:

- *Material:Pin:Brass/Tin over Nickel
 Insulator:Nylon 66,UL94V-0
- *Mates with CJT C2504HFA,AH-XP series Housing
- *Color:Beige

Ordering Information:

C2504WV-XP - *** - **
 1 2 3

- 1.Part No.
- 2.Material:
 (blank):Nylon 66,UL94V-0
 GWT:Nylon 66,UL94V-0,GWT 750°C
- 3.Finish:
 (blank):Tin over Nickel
 G:Gold over Nickel

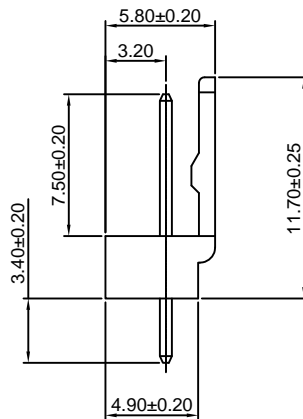
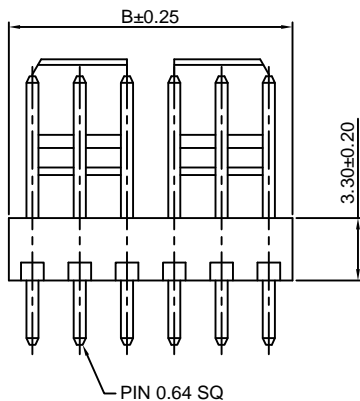
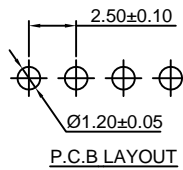
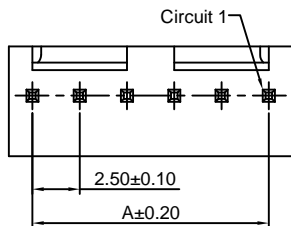
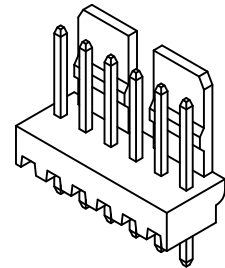

Ordering Information & Dimensions:

PART NO.	Dimensions	
	A	B
2P	2.50	5.00
3P	5.00	7.50
4P	7.50	10.00
5P	10.00	12.50
6P	12.50	15.00
7P	15.00	17.50
8P	17.50	20.00
9P	20.00	22.50
10P	22.50	25.00
11P	25.00	27.50
12P	27.50	30.00
13P	30.00	32.50
14P	32.50	35.00
15P	35.00	37.50
16P	37.50	40.00
17P	40.00	42.50
18P	42.50	45.00
19P	45.00	47.50
20P	47.50	50.00

Unit: mm

C2504WR-XP

2.50mm Pitch 90° Wafer

Reference Informations:

- *Material: Pin: Brass/Tin over Nickel
Insulator: Nylon 66, UL94V-0
- *Mates with CJT C2504HFA, AH-XP series Housing
- *Color: Beige

Ordering Information:

- C2504WR-XP - *** - **
1 2 3
1. Part No.
 2. Material:
(blank): Nylon 66, UL94V-0
GWT: Nylon 66, UL94V-0, GWT 750°C
 3. Finish:
(blank): Tin over Nickel
G: Gold over Nickel

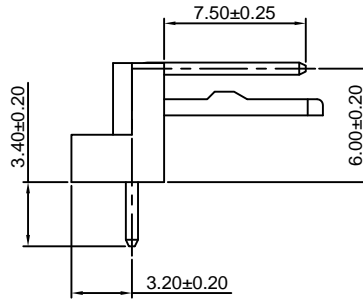
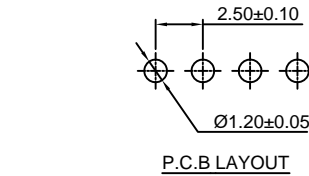
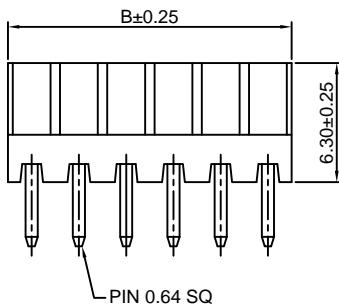
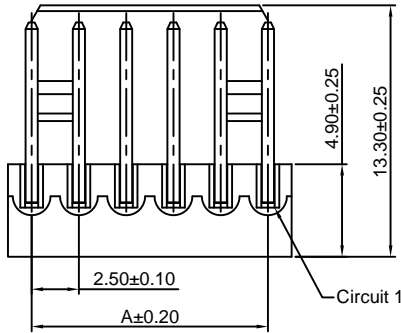
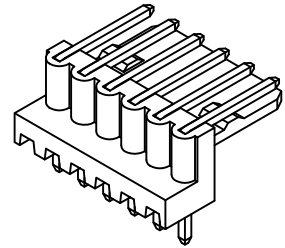

Ordering Information & Dimensions:

PART NO.	Dimensions	
	A	B
2P	2.50	5.00
3P	5.00	7.50
4P	7.50	10.00
5P	10.00	12.50
6P	12.50	15.00
7P	15.00	17.50
8P	17.50	20.00
9P	20.00	22.50
10P	22.50	25.00
11P	25.00	27.50
12P	27.50	30.00
13P	30.00	32.50
14P	32.50	35.00
15P	35.00	37.50
16P	37.50	40.00
17P	40.00	42.50
18P	42.50	45.00
19P	45.00	47.50
20P	47.50	50.00

Unit: mm

C2504WVR-XP

2.50mm Pitch 90° Wafer

Reference Informations:

- *Material: Pin: Brass/Tin over Nickel
Insulator: Nylon 66, UL94V-0
- *Mates with CJT C2504HFA, AH-XP series Housing
- *Color: Beige

Ordering Information:

- C2504WVR-XP - *** - **
1 2 3
1. Part No.
 2. Material:
(blank): Nylon 66, UL94V-0
GWT: Nylon 66, UL94V-0, GWT 750°C
 3. Finish:
(blank): Tin over Nickel
G: Gold over Nickel

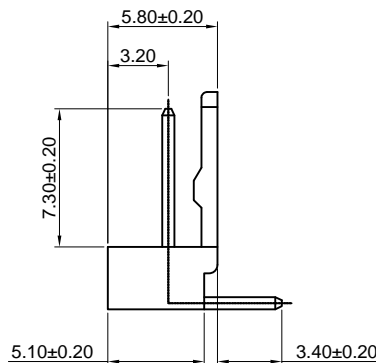
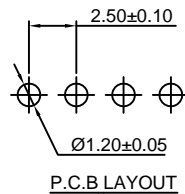
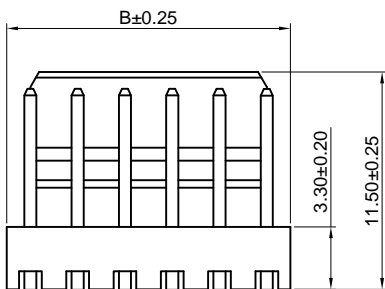
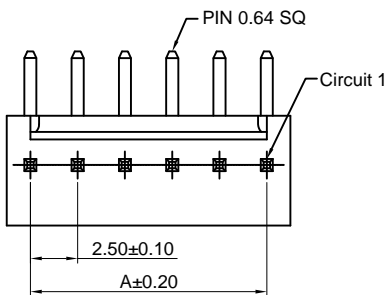

Ordering Information & Dimensions:

PART NO.	Dimensions	
	A	B
2P	2.50	5.00
3P	5.00	7.50
4P	7.50	10.00
5P	10.00	12.50
6P	12.50	15.00
7P	15.00	17.50
8P	17.50	20.00
9P	20.00	22.50
10P	22.50	25.00
11P	25.00	27.50
12P	27.50	30.00
13P	30.00	32.50
14P	32.50	35.00
15P	35.00	37.50
16P	37.50	40.00
17P	40.00	42.50
18P	42.50	45.00
19P	45.00	47.50
20P	47.50	50.00

Unit: mm